



The Best
Products
at the
Lowest
Prices!

www.MonoMachines.com
800.592.1306

USER'S MANUAL

BF-041S/BF-041W

First of all, we would like to thank you very much for purchasing a PLUS Copyboard MODEL BF-041. Please read this User's Manual before using the copyboard to get the best performance out of the product.

We recommend that you keep this manual for future reference.

○—————	—————○
FEATURES	E-3
PRODUCT FEATURES	E-4
CONTROL FUNCTIONS	E-5
HOW TO USE	E-7
PLUS COPYBOARD SOFTWARE	E-12
MAINTENANCE/HOW TO STORE	E-16
HANDLING PRECAUTIONS	E-16
TROUBLE SHOOTING	E-18
SPECIFICATIONS	E-19

PACKAGE CONTENTS

Please be sure all of the following items are included in the carton of the BF-041S and BF-041W COPYBOARD

- Copyboard main unit [1]

ACCESSORIES

- Set of Dry-eraseable markers (one each black, red and blue) [3]
- Eraser [1]
- Print Paper (30 m/98 ft) [1]
- User's Manual [1]
- Stabilizer [4]
- Assembly Manual [1]
- AC power cable [1]
- USB cable [1]
- CD-ROM (including software and manual) [1]

EXPLANATION OF UL REGULATORY LABEL (USA ONLY)

PLEASE NOTE:

The description "Computer Rooms" on the label located on the rear of the copyboard, refers to areas where an abundance of computer control equipment (such as high output servers) is being used, It does NOT refer to environments such as offices or classrooms where there are simply PC's being used.

UL regulations require that we place a warning label in regard to this item being used in a "Computer Room". Please understand that this equipment will in no way interfere with the running of computer equipment or peripherals. The UL regulation simply applies to all items that contain flammable material in excess of a specified area, We would like to further stress that there is no inherent risk of this equipment causing a fire. It is only pointing out that should a fire occur, then this equipment will also burn along with any other flammable materials contained in the room.

Should you have any questions whatsoever about this information, please call PLUS Corporation of America directly at (503) 748-8700

FEATURES

- The board size is BF-041S: W1300 mm × H920 mm (51.2 × 36.2 inches), BF-041W: W1800 mm × H920 mm (70.9 × 36.2 inches)-large enough to show all the ideas that you discuss during your meetings, without any omissions.

- Information on the sheet can be printed immediately onto a sheet of A4/Letter paper.

Those who attend the meeting can concentrate on the subject, as there is no need to waste time writing what is already on the board.

- The board has two pages. You can change a page by pushing FEED/STOP key or by pushing the sheet with the palm of your hand.

- Standard USB interface.

The copyboard can be connected to a computer and each sheet of data can be captured onto the computer as digital data.



The Best
Products
at the
Lowest
Prices!

www.MonoMachines.com
800.592.1306

PRODUCT FEATURES

FRONT

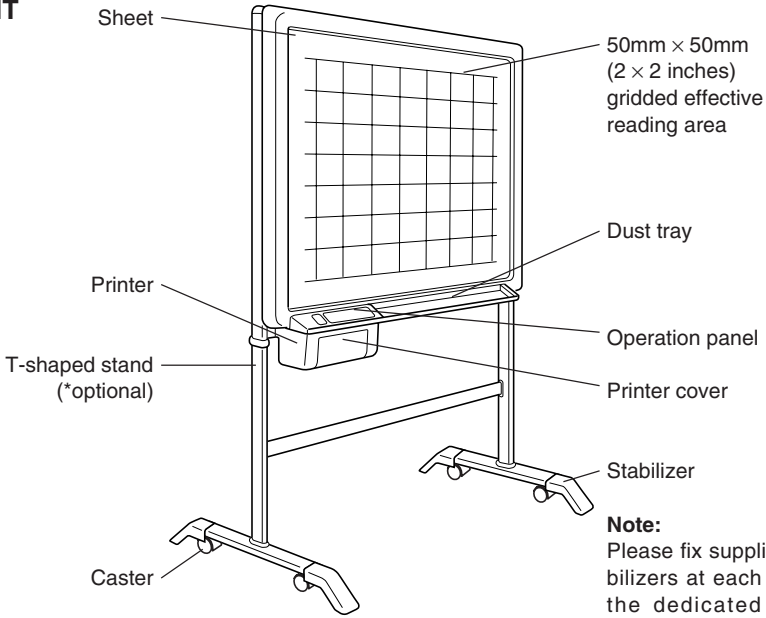

Note:

Please fix supplied stabilizers at each end of the dedicated stand when you mount the BF-041 on it for stable and safe usage.

REAR

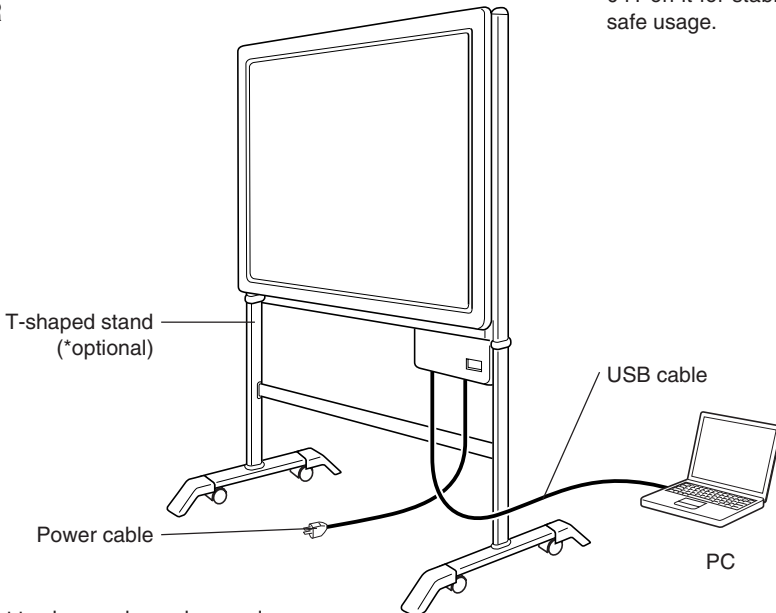

* Subject to change depends on sales area.

CONTROL FUNCTIONS

OPERATION PANEL (BF-041S)

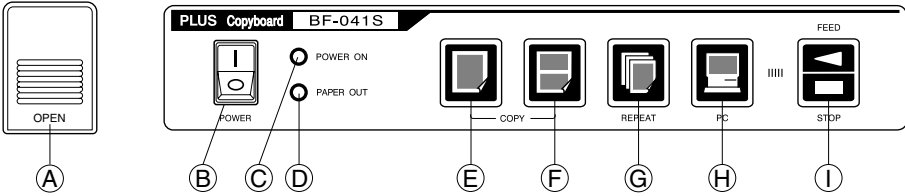

- A** Opening button Press this button to open the printer cover when replacing the thermal paper.
- B** Power switch Press “ I ” to turn ON the power of the copyboard.
- C** Power lamp Press the ON switch, and the green lamp will blink on and off. The lamp will stay lit (green) when the copyboard is ready for operation.
- D** Paper warning lamp When the thermal paper has run out, the red lamp will light. Load a new roll of print paper (30 m/98 ft length).
- E** One-page copy key This is used when one page of the sheet is copied onto A4/Letter paper.
- F** Two-in-one page key This is used when copying two pages of the sheet at a reduced size onto A4/Letter paper. At this time, the image is compressed horizontally.
- G** Repeat key Use this to make additional copies after making a one-page copy. During this operation, the sheet does not move.
- H** PC key Use this to capture the image on one page onto the computer. During this operation, the image is being scanned into the PC. It is not printed.
- I** Feed/stop key This is used to move the sheet. Pressing this key scrolls the sheet to the left by one page and then automatically stops.
Pressing the key while the sheet is moving stops it immediately. This can also be used when paper has run out and must be refilled.
If this key is pressed during the copying operation, the copying operation ends and the printer stops.

CONTROL FUNCTIONS

OPERATION PANEL (BF-041W)

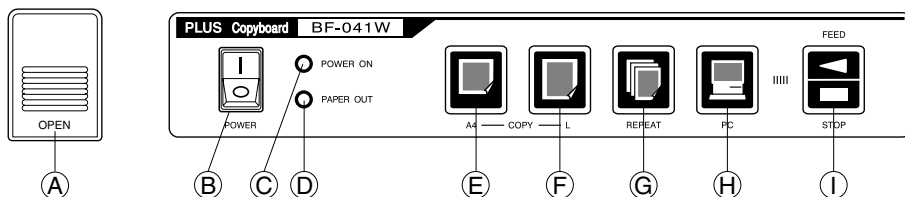

- A** Opening button Press this button to open the printer cover when replacing the thermal paper.
- B** Power switch Press “ I ” to turn ON the power of the copyboard.
- C** Power lamp Press the ON switch, and the green lamp will blink on and off. The lamp will stay lit (green) when the copyboard is ready for operation.
- D** Paper warning lamp When the thermal paper has run out, the red lamp will light. Load a new roll of print paper (30 m/98 ft length).
- E** A4 size copy key This is used when copying one page of the sheet at a compressed size onto A4/Letter paper. At this time, the image is compressed horizontally.
- F** A4-L copy key This is used when one page of the sheet is copied onto A4-L paper. The copyboard produces a copy with the same aspect ratio as that of the original image.
- G** Repeat key Use this to make additional copies after making a one-page copy. During this operation, the sheet does not move.
- H** PC key Use this to capture the image on one page onto the computer. During this operation, the image is being scanned into the PC. It is not printed.
- I** Feed/stop key This is used to move the sheet. Pressing this key scrolls the sheet to the left by one page and then automatically stops.
Pressing the key while the sheet is moving stops it immediately. This can also be used when paper has run out and must be refilled.
If this key is pressed during the copying operation, the copying operation ends and the printer stops.

HOW TO USE

BEFORE USE...

Please fix supplied stabilizers at each end of the dedicated stand when you mount the BF-041 on it for stable and safe usage.

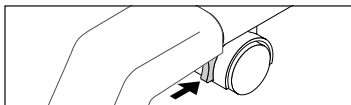

Please lock the caster stoppers by pressing the lower portion of the lock button.

Plug in and turn ON the power switch. Power lamp blinks for a couple of seconds, then stays lit.

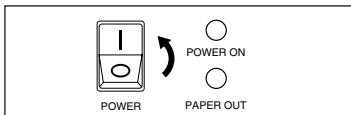

The fluorescent lamp inside the copyboard turns on, and then the copyboard becomes ready for operation.

Notice: There is a case that the warm-up time becomes a little longer for good and stable printing quality.

WHEN COPYING...

When copying one page:

Press the one-page copy key. At this time the sheet scrolls by one page and the written contents are copied onto A4/ Letter paper.

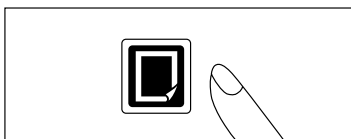

When copying reduced two-page in one copy (BF-041S only):

Press two-in-one page copy key. At this time the sheet scrolls by two pages, and the written contents are reduced to A4/Letter size and copied.

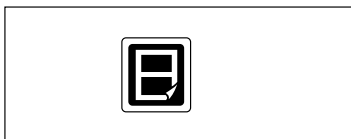

When copying onto A4-L paper (BF-041W only):

Press A4-L copy key. At this time the sheet scrolls by one page, and the written contents are reduced to A4-L size (210 × 400 mm/8.5 × 15.7 inches) and copied.



Tear-off print paper

When copying is completed, pull the tip of the print paper upwards and tear it off with the edge of the outlet.

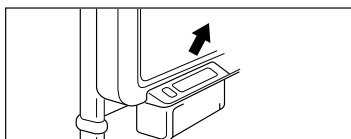

Press the feed/stop key to cancel the copy operation immediately. The printer stops after completion of copying up to that point.



HOW TO USE

WHEN SCROLLING THE SHEET FORWARD...

Scrolling by using key

Press the feed/stop key. Then, the sheet scrolls to the left by one page and stops. It stops immediately when the feed/stop key is pressed during the scrolling operation.

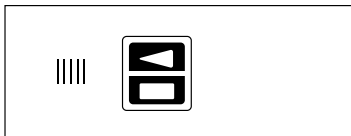

Manual scrolling

It is also possible to scroll the sheet manually. In this case, it can be scrolled in either direction; to the right and left. However, manual scrolling at an excessively high speed must be avoided as it occasionally causes problems.

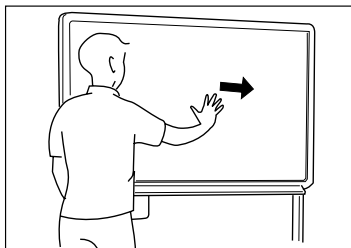

WHEN REPLACING PRINT PAPER...

1. Press the opening button to open the printer cover.

Take out the core of consumed print paper from the printer.

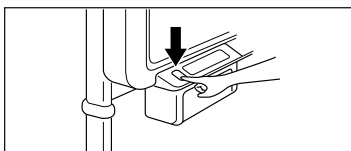

2. The paper should feed from the top.

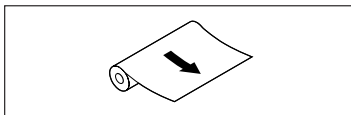

3. As illustrated, set it in so that the tip of the new roll of print paper extends about 20 cm/ 8 inches from the outlet.

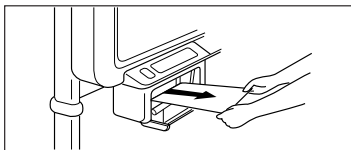

4. Push both ends of the hatch closed until it locks with a clicking noise. At this time, make sure that the print paper has not slipped.

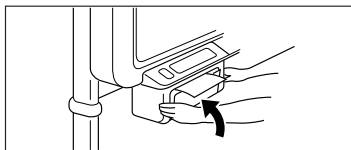

5. Tear off extra print paper from the printer outlet.

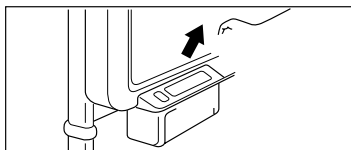

HOW TO USE

Replace the print paper in the following situations

- When a red line appears at the edges of the print paper. The red line will appear when there is only about one meter (3 feet) or so of print paper left on the roll.
- When the paper warning lamp lights red.

Note:

- Please use only the correct type of print paper.
- Particular attention must be given to the winding direction of the print paper, since copying cannot be performed if the winding direction of the print paper is reversed.
- Be sure to keep the print paper straight when loading, failure to do so may cause wrinkling or tearing of the paper during the copy function.

Standby Mode

If there is no key operation for about 120 min., a fluorescent lamp inside the copyboard automatically turns off and the unit goes into standby mode to save power consumption. (At this time, the power indicator light stays on.) If at any time any key is pressed, the fluorescent lamp lights again, and the normal operating condition is restored.

How to store Image Files on a Computer

The followings describe the procedure for downloading image files from the COPYBOARD to a computer, displaying and printing it out.

1. Preparation for installing software

Put the supplied CD-ROM on the optical drive of the computer and install TWAIN driver and PLUS Image Viewer.

* If any application which supports TWAIN is already installed into a computer, you need to install only the TWAIN Driver.

2. Connect the copyboard and a computer using the USB cable, then turn the power of the copyboard on.

3. Install the dedicated USB driver into your computer.

(It is required only at first time when you use the copyboard with the computer.)

4. Select “PLUS Copyboard BF-041” from “Choose TWAIN source” of “File” menu

5. Start “BF-041 Twain Driver” from “Acquire TWAIN source” of “File” menu

6. Push PC key of the control panel or click PC button of the software, then the image on the sheet is scanned and transferred to the computer and saved as image data.

* For a detailed explanation, see Page E-14.

HOW TO USE

How to customize the operating configuration (BF-041 Setup Utility Software)

The following operating configurations of the BF-041 can be changed using the BF-041 Setup Utility Software.

- **Auto Power Off Time**

If no button is pressed after the power is turned on, the lamp automatically turns off after 120 minutes and the copyboard goes into standby mode. You can change this setting considering the time of your meetings, for example.

- 30 min. (min)–240 min. (max)
- Default: 120 min.

- **Warm-up Time**

Longer warm-up time is recommended if you use the copyboard in lower temperature or if dark lines appear in the horizontal direction on the output image.

- 0 sec. (min)–120 sec. (max)
- Default: 0 sec.

- **Brightness**

The brightness of the image can be changed depending on the user's operating environment, such as the color and condition of markers. The higher the value, the darker the image will be scanned.

- 70% (min)–90% (max)
- Default: 80%

1. Preparation for installing software

Put the supplied CD-ROM on the optical drive of the computer and install "BF-041 Setup Utility".

2. Connect the copyboard and a computer using a USB cable, then turn the power of the copyboard on.

3. Install the dedicated USB driver into your computer.

(It is required only for the first time you use the copyboard with the computer.)

4. Start "BF-041 Setup Utility" then choose the condition you would like to change.

5. Keep the CD-ROM in a safe convenient location, so that it is available to install drivers on other PCs.

* For a detailed explanation, see Page E-15.

HOW TO USE

Quick Calibration

For optimum scanning condition, perform the Quick Calibration after replacing the fluorescent lamp or if dark lines appear in the horizontal direction on the output image.

1. Clean the sheet surface

First, clean a strip about 20 cm (8 inches) wide along the left side of the sheet surface. Make sure the sheet is completely clean and there are no marker traces left.

* Apply some water to a soft cloth, wring out thoroughly, then wipe the sheet clean. For tough dirt, wipe using a clean cloth with a solution of diluted neutral detergent, then wipe again with a cloth dampened with water to remove all traces of the detergent.

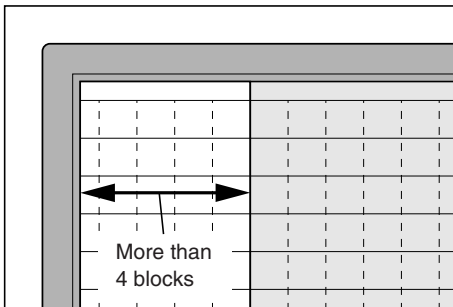

2. Start Quick Calibration

- 1) Turn off the power.
- 2) Turn on the power while pressing One-page copy key(BF-041S) or A4 size copy key(BF-041W)
- 3) It goes into warm-up mode. Both Power lamp and Paper warning lamp blink simultaneously, and the fluorescent lamp lights. The sheet stays still until the warm-up finishes (approximately 5 minutes).
- 4) The sheet automatically moves about 3 blocks of ruled line and calibration is performed.
- 5) When the Power lamp stays lit, the copyboard is ready for normal operation.
 - * If both Power lamp and Paper warning lamp keep blinking alternately, please try Quick Calibration again from the first step.
 - * Do not start using the copyboard until the sheet has completely dried.

PLUS COPYBOARD SOFTWARE

Before Using the Software

Software Contents and Overview

The supplied CD-ROM contains the software and manuals described below. See the Help information of each program for information about how to use the software.

• USB Driver

This driver software makes the computer recognize the BF-041 when they are connected using a USB cable.

• TWAIN Driver

This drive is used to acquire the scanned data into a computer as an image.

* This driver may not work on some applications.

* This driver conforms to TWAIN standard (ver. 1.9).

• Setup Utility

This is a utility for customizing the BF-041 configuration.

• User's Manual

The User's Manual is stored on the CD-ROM in PDF format.

• PLUS Image Viewer

This utility is used to display the images stored in a personal computer or print it out.

• Acrobat Reader

This software is used to view PDF files.

• Browsing the CD-ROM

Explorer running on the personal computer is used to display the contents of the CD-ROM.

• Copyrights and usage conditions

This opens the copyrights, usage conditions, etc.

Note:

When installing on Windows 2000, please install the software with "Administrator" authority (i.e., a user having administrator authority).

When installing on Windows XP, please install the software with "Computer Administrator" authority (account).

Notice:

Format for HELP

The help for the PLUS Image Viewer and the Setup Utility the online help system that is used for Microsoft HTML Help.

Operating Environment

Supported OS: Microsoft Windows 98SE / Me / 2000 Professional (Service Pack 4 or later) / XP (HomeEdition / Professional Edition Service Pack 2 or later)

Supported PC: IBM PC/AT or completely compatible machines that operate the aforementioned OS

CPU: Pentium II or later

Memory: Windows 98SE / Me (64 MB or bigger), Windows 2000 (128 MB or bigger), Windows XP (256 MB or bigger)

Free hard disk space: 40 MB or bigger

Display resolution: 800 × 600 pixels or higher

Peripheral devices: a CD-ROM / DVD-ROM drive, a standard USB port (USB 1.1 or 2.0)

Web browser: Internet Explorer 6.0 or later

Note:

• All operations are not guaranteed under the aforementioned operating environment.

• Not compatible with Windows 95, NT, 2000 Server or Server 2003.



[Start menu]

PLUS COPYBOARD SOFTWARE

Connection to a computer

Turn the copyboard's power on and connect the copyboard to the computer using the USB cable.

Note:

- Use a USB-IF certified shielded USB cable.
- When connecting for the first time, the USB driver must be installed on the computer.
- For Windows 98 or Windows Me, the operating system installation CD-ROM or floppy disc may be required.

USB connections to a Windows 98 or Me computer

To use the copyboard with USB connections to a computer running on Windows 98 or Me, set up the driver using the procedure described below.

Driver setup (Windows 98/Me)

1. Turn on the computer's power and start up Windows.
2. Turn on the copyboard's power and connect it to the computer using the USB cable.
3. When the "USB compatible device" or "New Hardware" is detected, click the "Next" button.
4. Select "Search for the best driver for your device. (Recommended)" (Windows 98), or "Specify the location of the device (Advanced)" (Windows Me), then click the "Next" button.
5. Set the included CD-ROM in the CD-ROM drive. If the setup window appears, click the "x" (close) button to close it.
6. Select only "Specify the location", type "D (CD-ROM drive): \BF041USB" in the text box, then click the "Next" button.
 - * Do not select "CD-ROM drive", as doing so sometimes prevents the right USB driver from being installed.
7. Once the driver is found, click the "Next" button.
8. Once installation of the USB compatible device's driver is complete, click the "End" button.

* The operating system installation CD-ROM or floppy disc may be required.

USB connections to a Windows 2000 or XP computer

To use the copyboard with USB connections to a computer running on Windows 2000 or XP, set up the driver using the procedure described below.

Driver setup (Windows 2000/XP)

1. Turn on the computer's power and start up Windows.
 - * Log in with the account having the authority to change the system settings (administrator).
2. Turn on the copyboard's power and connect it to the computer using the USB cable.
3. When the "New hardware wizard" starts, click the "Next" button.
4. When "BF041 S/W" is detected, select "Search for a suitable driver for my device (recommended)" (Windows 2000), or "Install from a list or specific location (Advanced)" (Windows XP), then click the "Next" button.
5. Set the included CD-ROM in the CD-ROM drive. If the setup window appears, click the "x" (close) button to close it.
6. Select only "Specify a location where to search", then click the "Next" button (Windows 2000), or select only "include this location in the search" (Windows XP).
 - * Do not select "CD-ROM drive", as doing so sometimes prevents the right USB driver from being installed.
7. Type "D (CD-ROM drive): \BF041USB" in the text box, then click the "Next" button.
8. Once the driver is found, click the "Next" button.
9. Once installation of the USB compatible device's driver is complete, click the "End" button.

PLUS COPYBOARD SOFTWARE

Saving the copyboard's data on the computer

The PLUS Image Viewer and TWAIN driver must be installed in order to save the data drawn on the copyboard onto the computer, display it and print it.

Notice:

When using a TWAIN compatible application, these operations are possible even if only the TWAIN driver is installed.

Installation

1. Preparations for installation

Quit any applications that are currently running on the computer. If not, installation may not be completed properly.

2. Set the included CD-ROM in the CD-ROM drive.

The menu window appears automatically.

If the menu window does not appear automatically, open the CD-ROM folder and double-click on "autorun.exe".

3. Select the required menu.

1) When "Image Viewer" is clicked, the TWAIN driver is installed simultaneously.

2) When "TWAIN driver" is clicked, only the TWAIN driver is installed.

3) When "Acrobat Reader" is clicked, Acrobat Reader (for reading the User's Manual) can be installed. If Acrobat Reader is not already installed on your computer, install it before attempting to read the User's Manual.

The installer is launched. Follow the messages displayed on the screen to install.

Once installation is completed, "Restart computer now?" appears. Click "Yes" to restart the computer.

Launching

On the computer, choose "Start" → "Programs" → "PLUS Copyboard" → "PLUS Image Viewer". The PLUS Image Viewer starts up.

* For details on using Image Viewer, see "PLUS Image Viewer Help".

Scanning the copyboard data

The copyboard's data can be scanned using the PLUS Image Viewer.

1. Click "TWAIN source" on the "File" menu.

2. Select "PLUS Copyboard BF-041", then click "Select".

3. Click "TWAIN Acquire" on the "File" menu.

→ The copyboard control panel appears.

→ If the control panel does not appear, check the connection of the USB cable and the copyboard's status.

4. Click the "PC" button on the copyboard control panel.

→ Copyboard scanning starts. Once scanning is completed, the scanned image is displayed on the computer's screen.

→ Scanning can also be started using the "PC Copy" key on the copyboard.

5. Click the "Close" button on the copyboard control panel to close the copyboard control panel and end the scanning operation.

Note:

Do not drag the copyboard control panel or operate other software during scanning, as doing so could interfere with the scanning operation.

PLUS COPYBOARD SOFTWARE

Using the Setup Utility

The copyboard's operating environment can be changed using the Setup Utility. Settings: Auto power off time, Warm-up time, Brightness adjustment.

Installation

1. Preparations for installation

Quit any applications that are currently running on the computer. If not, installation may not be completed properly.

2. Set the included CD-ROM in the CD-ROM drive.

The menu window appears automatically.

If the menu window does not appear automatically, open the CD-ROM folder and double-click on "autorun.exe".

3. Click "Setup Utility".

The installer is launched. Follow the messages displayed on the screen to install.

Launching

On the computer, choose "Start" → "Programs" → "PLUS Copyboard" → "BF-041 Setup Utility". The Setup Utility starts up.

* For details on using the Setup Utility, see "BF-041 Setup Utility Help".

Uninstalling the software

If you no longer need software you have installed, use the procedure below to uninstall it.

1. Select "Start" → "Control Panel".

The control panel window is displayed.

2. Double-click "Add/delete programs or applications" (the name differs according to the operating system).

The "Program add/delete properties" window appears.

From the list, select the program you want to delete (uninstall), then click "Change/Delete". The add/delete wizard window appears.

3. Select the "Delete" button on the wizard window, then click "Next".

Uninstalling starts.

* Use "Add/delete applications" for Windows XP.



The Best
Products
at the
Lowest
Prices!

www.MonoMachines.com
800.592.1306

MAINTENANCE/HOW TO STORE

Carry out the following maintenance procedures periodically to ensure high quality copying performance at all times.

1. Cleaning of the sheet surface

When the surface gets stained, wipe it off with a slightly damp cloth. Also, if the stain is particularly stubborn, use a solution of water-thinned neutral detergent to wipe it off. Do not start using the copyboard until the sheet has completely dried.

2. Cleaning of tray and decorative frame

Wipe away any dirt or residue left by the markers in the tray and the decorative frame with a slightly damp cloth.

HANDLING PRECAUTIONS

FOR SAFE USE

1. Avoid placing the copyboard in hot spots where it is exposed to direct sunlight or in places where exposed to wind coming directly from an air conditioning duct.
2. When using sticky tape on the surface of the sheet, do not leave it on for a long time. Moreover, after removing it, wipe the sheet clean. Do not hit or pierce the sheet with any hard or sharp objects.
3. Do not leave writing or marks on the sheet for a long time since it sometimes become difficult to erase.
4. Be careful not to stain the joints of the sheet as there have been very rare cases where such stains have been copied.
5. As thinner, benzine, alcohol, etc., may discolor or mark the unit and the sheet, never use such chemicals when cleaning.
6. Use only the correct type of print paper.

When storing thermal print paper, avoid the following places. This is important because storage in such places may cause color development or discoloration.

1. Places where the paper is exposed to direct sunlight.
2. Places where the paper is exposed to temperatures of more than 35°C and humidity of 85% or over.
3. Places adjacent to alcohol, thinner, benzine, ammonia, etc.

HANDLING PRECAUTIONS

7. When replacing print paper, do not place any objects on the open printer cover or do not put your elbows on it.
 8. After use, make sure to turn OFF the power switch. In addition, when it is not to be used for a long time, make certain that the plug of the power cable is pulled out from the outlet.
 9. Always use the correct type of marker. Be careful not to use other markers as the sheet may be damaged or, in some cases, the ink may be difficult to remove.
10. Write within the effective reading area shown below.

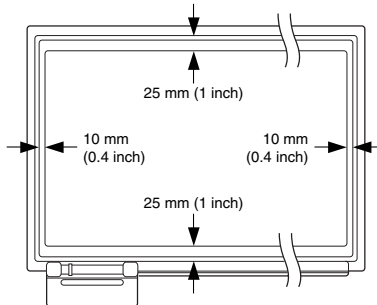

11. When moving the copyboard, unlock the caster stoppers, hold both the right and the left sides of the main unit firmly, and avoid any sudden jolts or shocks.

TROUBLE SHOOTING

Please check the following matters before making a request for servicing.

Condition	Please Check
Pressing the POWER button does not switch on the power.	<ul style="list-style-type: none">• Check that the power cable is securely plugged into the power outlet.
A press of the COPY button does not result in printing. (Print paper does not come out)	<ul style="list-style-type: none">• Check if paper warning lamp (red) is lit.<ul style="list-style-type: none">> Check if there is print paper in the built-in printer.> Close and lock the printer cover completely• Print paper is jammed<ul style="list-style-type: none">> Take out the jammed paper.• Print paper roller (black rubber roller) is dusty<ul style="list-style-type: none">> Open the printer cover, and clean the rubber.
Although printer is functioning, nothing is copied on recording paper	<ul style="list-style-type: none">• Check if winding direction of print paper is set on reverse. (No copying is made on back of print paper)<ul style="list-style-type: none">> Change the direction then put into the printer. Paper should be feeding from the top of the roll.
Print is very pale. Some letters or lines are not read.	<ul style="list-style-type: none">• The drawing or writing on the sheet is pale, patchy or the lines are thin.<ul style="list-style-type: none">> Write boldly and deeply. Use new markers.• Printer cover is not closed completely.<ul style="list-style-type: none">> Close and lock the printer cover completely• Operating condition<ul style="list-style-type: none">> Adjust the brightness using the setup utility.> Adjust the warm-up time using the setup utility.
There are black bands at the top and bottom of the copy.	<ul style="list-style-type: none">• CCD alignment may have a problem. (Black Band)<ul style="list-style-type: none">> Perform the quick calibration procedure. (See Page E-11) Extend the Warm-up Time using the BF-041 Setup Utility software.• The grid line of the sheet is copied.<ul style="list-style-type: none">> Adjust the brightness using the setup utility.• The fluorescent lamp may be at the end of its service life.<ul style="list-style-type: none">> Contact your store of purchase or a PLUS customer center to have the lamp replaced.
No operation after installing the USB driver	<ul style="list-style-type: none">• The USB driver is not registered in Device Manager. (! mark is shown.)<ul style="list-style-type: none">> Uninstall the driver, then install it again.
The copyboard is not recognized by a computer.	<ul style="list-style-type: none">• The copyboard is not ready for operation.<ul style="list-style-type: none">> Make sure the power is on and check the connection of the AC cable and the USB cable.• Connect the USB cable via a USB hub<ul style="list-style-type: none">> Connect the USB cable directly between the copyboard and a computer.
Writing on the sheet does not erase with the eraser	<ul style="list-style-type: none">• Did you use a marker other than one specifically designated for the copyboard?<ul style="list-style-type: none">> Clean the sheet first(Apply some water or neutral detergent to a soft cloth, wring out thoroughly, then wipe the sheet carefully and gently.), then use dedicated dry erase markers.
Printed images are dirty.	<ul style="list-style-type: none">• Is there a lot of marker residue on the sheet?<ul style="list-style-type: none">> If the sheet is dirty, apply some water or neutral detergent to a soft cloth, wring out thoroughly, then wipe the sheet carefully but gently.> Try performing the quick calibration. (See Page E-11.)

* If no satisfactory result can be achieved even after the above, contact the suppliers or our company.

SPECIFICATIONS

Item	Specification (BF-041S)	Specification (BF-041W)
Board surface size	W1300 × H920 mm (51.2 × 36.2 inches)	W1800 × H920 mm (70.9 × 36.2 inches)
Effective reading area	W1240 × H880 mm (48.8 × 34.6 inches)	W1740 × H880 mm (68.5 × 34.6 inches)
Number of pages	2 pages	2 pages
Sheet driving method	One direction endless drive	One direction endless drive
Grid	50 mm (2 inches) squares	50 mm (2 inches) squares
Writing instruments	Dry Erase Whiteboard markers (black/red/blue)	Dry Erase Whiteboard markers (black/red/blue)
Reading method	CCD sensor	CCD sensor
Print method	Thermal printing	Thermal printing
Print density	8 dot/mm	8 dot/mm
Print paper	Special thermal sensitive paper (30 m/98 ft roll)	Special thermal sensitive paper (30 m/98 ft roll)
Size of print paper	A4 size (210 × 297 mm), Letter size (8.5 × 11 inches)	A4 size (210 × 297 mm), Letter size (8.5 × 11 inches)
Print color	Black	Black
Scan speed	1-page copy: 11 sec/copy Two-in-one page copy: 22 sec/copy	1-page copy: 15 sec/copy
Operating conditions	Temperature: 10–35°C Humidity: 30–85% (No condensation)	Temperature: 10–35°C Humidity: 30–85% (No condensation)
Power source	100–120 V, 220–240 V The condition is subject to change depends on sales area	100–120 V, 220–240 V The condition is subject to change depends on sales area
Power consumption	60W at stand-by, 120 W at operation	60W at stand-by, 120 W at operation
Outer dimensions	W1470 × D600 × H1885 mm (W57.9 × D23.6 × H74.2 inches)	W1970 × D600 × H1885 mm (W77.6 × D23.6 × H74.2 inches)
Weight	37 kg/81.5 lb	43 kg/94.7 lb
Others	Consumables Thermal print paper (30 m/98 ft) Markers Eraser	Thermal print paper (30 m/98 ft) Markers Eraser

* Specifications are subject to change without notice for improvement.

Auto Power Off

If no button is pressed after the power is turned on, the fluorescent lamp automatically turns off after 120 minutes (= the setting at factory shipment) though the Power Lamp is stay lit. It is standby mode to save power consumption. When any COPY related button is pressed, the fluorescent lamp turns on again and the copyboard comes back to normal mode.

Placing this unit next to equipment or buildings (such as broadcasting stations) where strong RF interference is generated may sometimes cause printing to become blurred or disordered when copies are made. This does not indicate a breakdown or problem in this unit.